

# ABS Stützrohr / ABS Supporting tube

XX-STUETZR-XXX



## Werkzeuge | Tools



## Sicherheitshinweise | Safety instructions



- DE** Die Anweisungen der Montageanleitung (1) und Sicherheitshinweise (2) sind strikt einzuhalten.
- EN** The information contained in the assembly instructions (1) and safety instructions (2) must be strictly observed.
- NL** De aanwijzingen in de montagehandleiding (1) en de veiligheidsvoorschriften (2) moeten strikt worden nageleefd.
- ES** Respete estrictamente las instrucciones del manual de montaje (1) y las indicaciones de seguridad (2).
- IT** È assolutamente necessario attenersi alle istruzioni di montaggio (1) e alle norme di sicurezza (2).
- FR** Les instructions de la notice de montage (1) et les consignes de sécurité (2) doivent être formellement respectées.
- PL** Należy ściśle przestrzegać instrukcji montażu (1) i wskazań bezpieczeństwa (2).
- DK** Montagevejledningens (1) anvisninger som også sikkerhedshenvisningerne (2) skal overholdes.
- CZ** Je nutné striktně dodržovat instrukce obsažené v montážním návodu (1) a v bezpečnostních pokynech (2).
- GR** Πρέπει να τηρούνται αυστηρά οι οδηγίες του εγχειριδίου συναρμολόγησης (1) και των υποδείξεων ασφαλείας (2).
- SK** Dôsledne dodržiavajte pokyny montážneho návodu (1) a bezpečnostné pokyny (2).
- TR** Montaj kılavuzunun (1) ve güvenlik uyarılarının talimatlarına (2) kesinlikle uyulmalıdır.
- NO** Det er svært viktig at instruksjonene i monteringshåndboken (1) og sikkerhetsheftet (2) følges.
- RUS** Необходимо строго соблюдать требования руководства по монтажу (1) и инструкции по безопасности (2).
- RO** Indicațiile din instrucțiunile de montare (1) și din broșura cu indicații de siguranță (2) trebuie respectate cu strictețe.
- FI** Asennusohjeen (1) ja turvaohjeihkosen (2) ohjeita on ehdottomasti noudatettava.
- SE** Anvisningarna till monteringsanvisningen (1) och säkerhetsmanualen (2) måste iakttas under alla omständigheter.
- HI** इंस्ट्रक्शन के निर्देशों (1) और सुरक्षा निर्देश मैनुअल (2) में दिये गये निर्देशों का सख्ती से अनुसरण किया जाना चाहिए।
- ZH** 必须严格遵守装配说明书 (1) 和安全须知单 (2) 中的指示。
- SQ** Jëpb alntzram baltelimebt wwarde fte flzfl ttrkfb (1) wktfb aršatad sllame (2) bmttfl dftë

## Kontakte | Contact persons

**Vertrieb & Technische Beratung**  
Sales & Technical Support  
+49 (0) 28 32 - 972 81 - 0  
vertrieb@absturzicherung.de

**Schulung**  
Training  
+49 (0) 28 32 - 972 81 - 254  
schulung@absturzicherung.de

**Montagevorbereitung**  
Assembly  
+49 (0) 28 32 - 972 81 - 260  
service@absturzicherung.de

## Mustertypenschild | Sample label

[ABS]

**ABS SAFETY GMBH** 3

Kevelaer, Germany  
info@absturzicherung.de  
www.absturzicherung.de

---

**Mustertypenschild /**  
**Sample only**

**Chargennummer /**  
**Batch number**

---

6 Normen / Standards

7 Max. Nutzer gleichzeitig (DIN EN 795:2012)

Max. No. of simultaneous users

11 Modellnummer / Model number

-

-

-

-

-

-

8

9

10

**Inhalt | Content**



ABS-Lock® III



ABS-Lock® III



ABS-Lock® X /  
ABS Weight OnTop Double

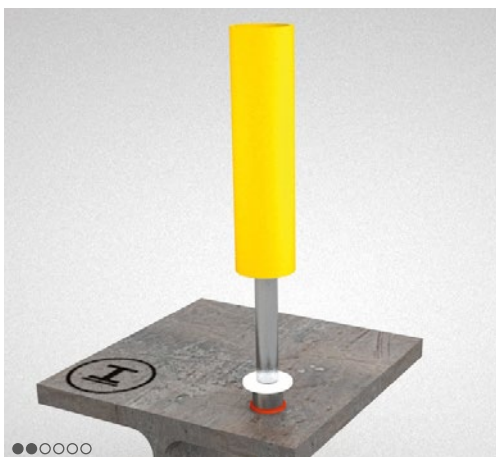
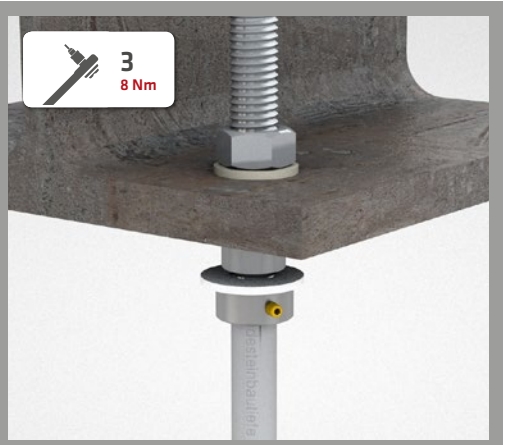
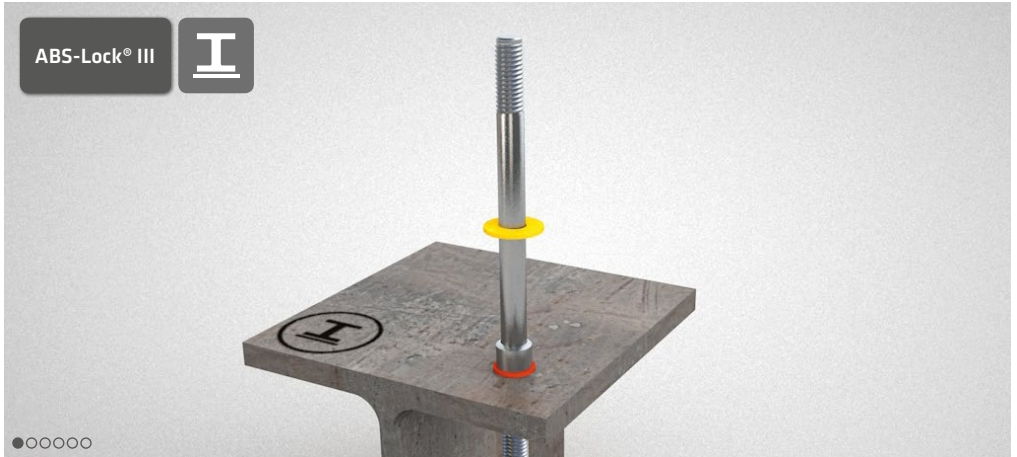



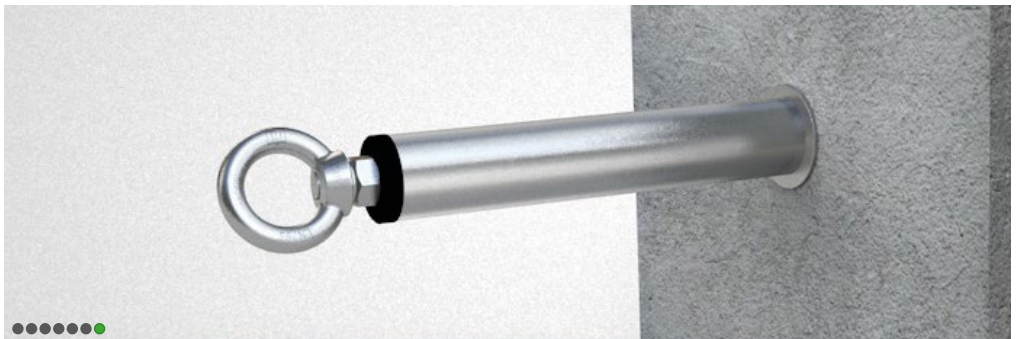
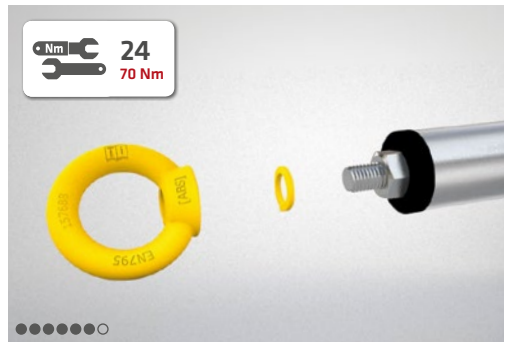
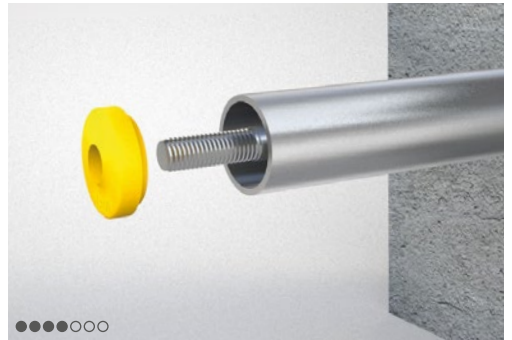
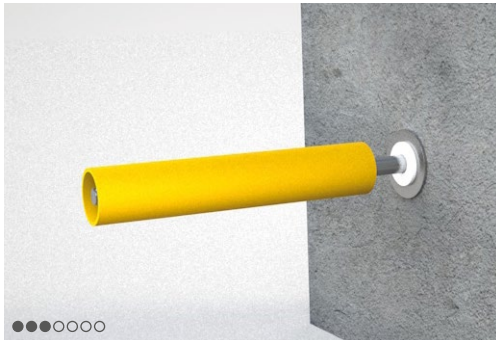
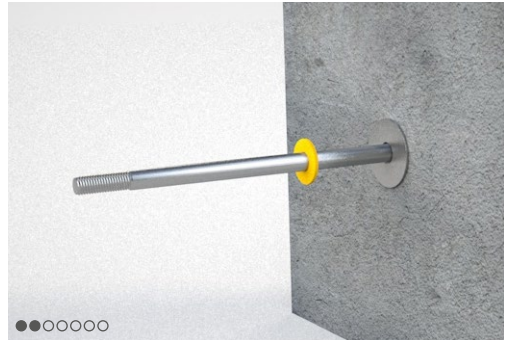
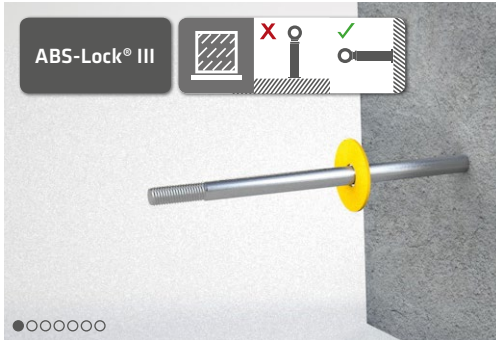

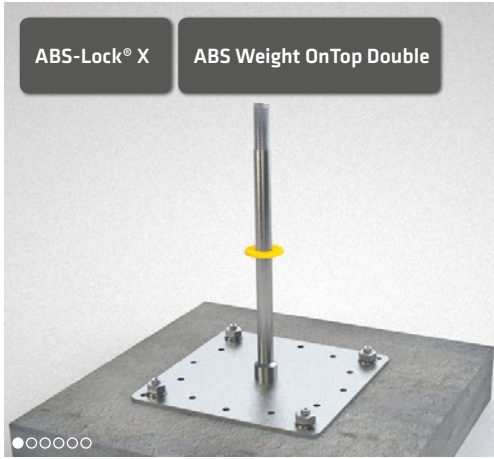

8 | ABS Stützrohr / ABS Supporting tube  
LX-STUETZR-XXX / W-OT-STUETZR-XXX



Nm 24  
70 Nm

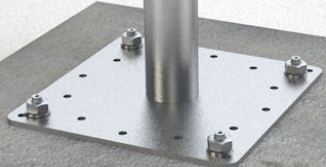



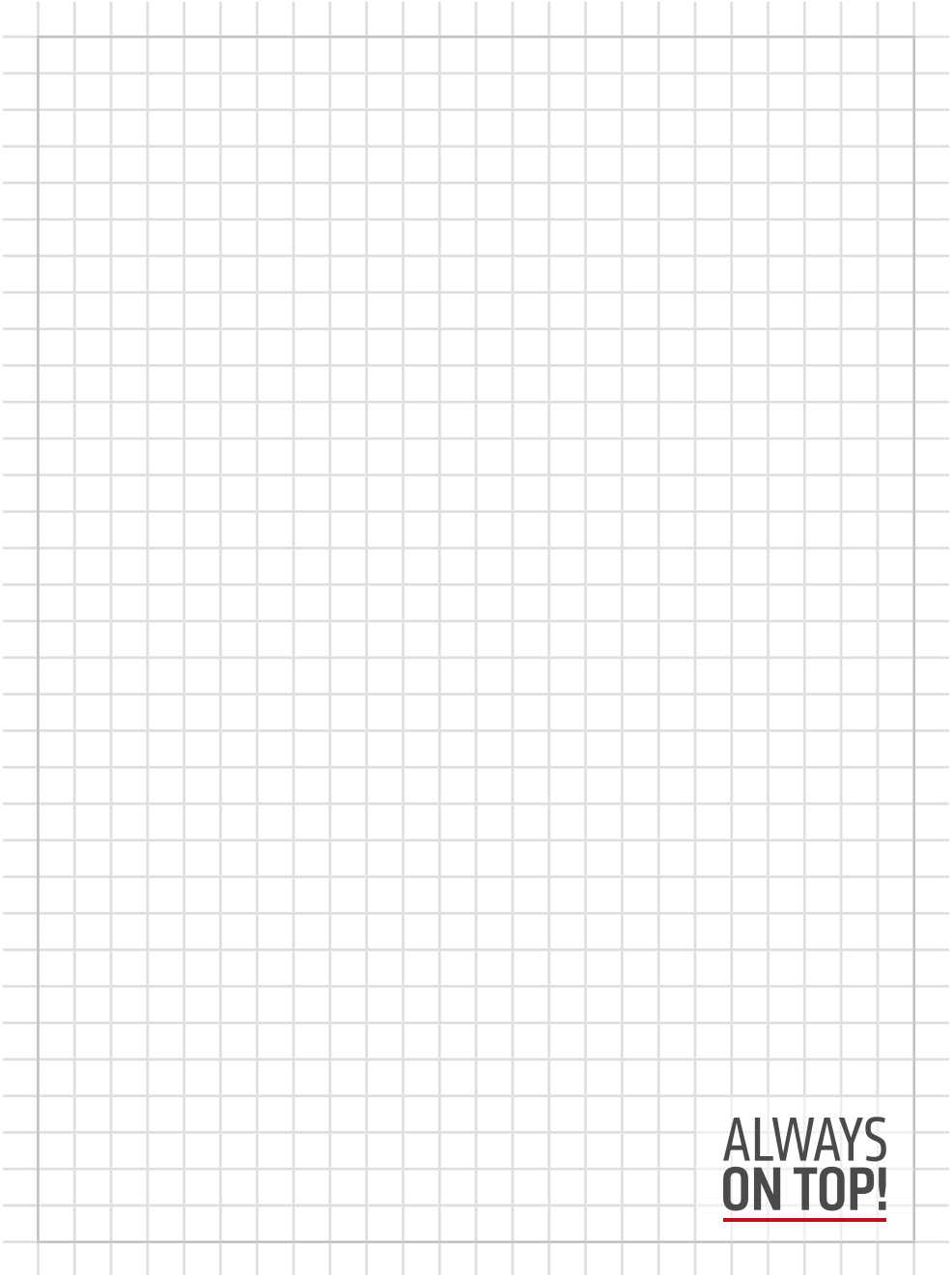

**ALWAYS  
ON TOP!**

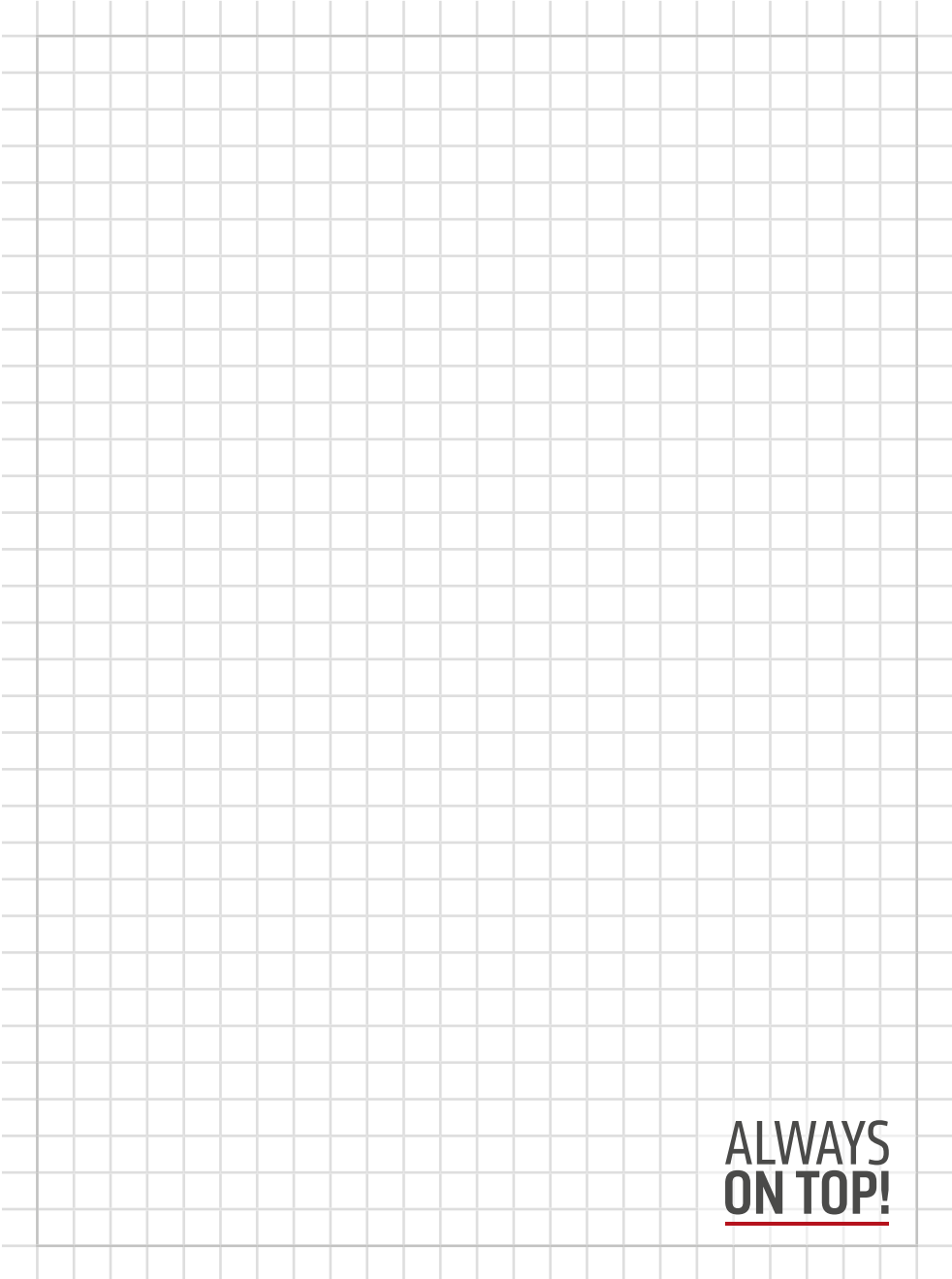

**ALWAYS  
ON TOP!**

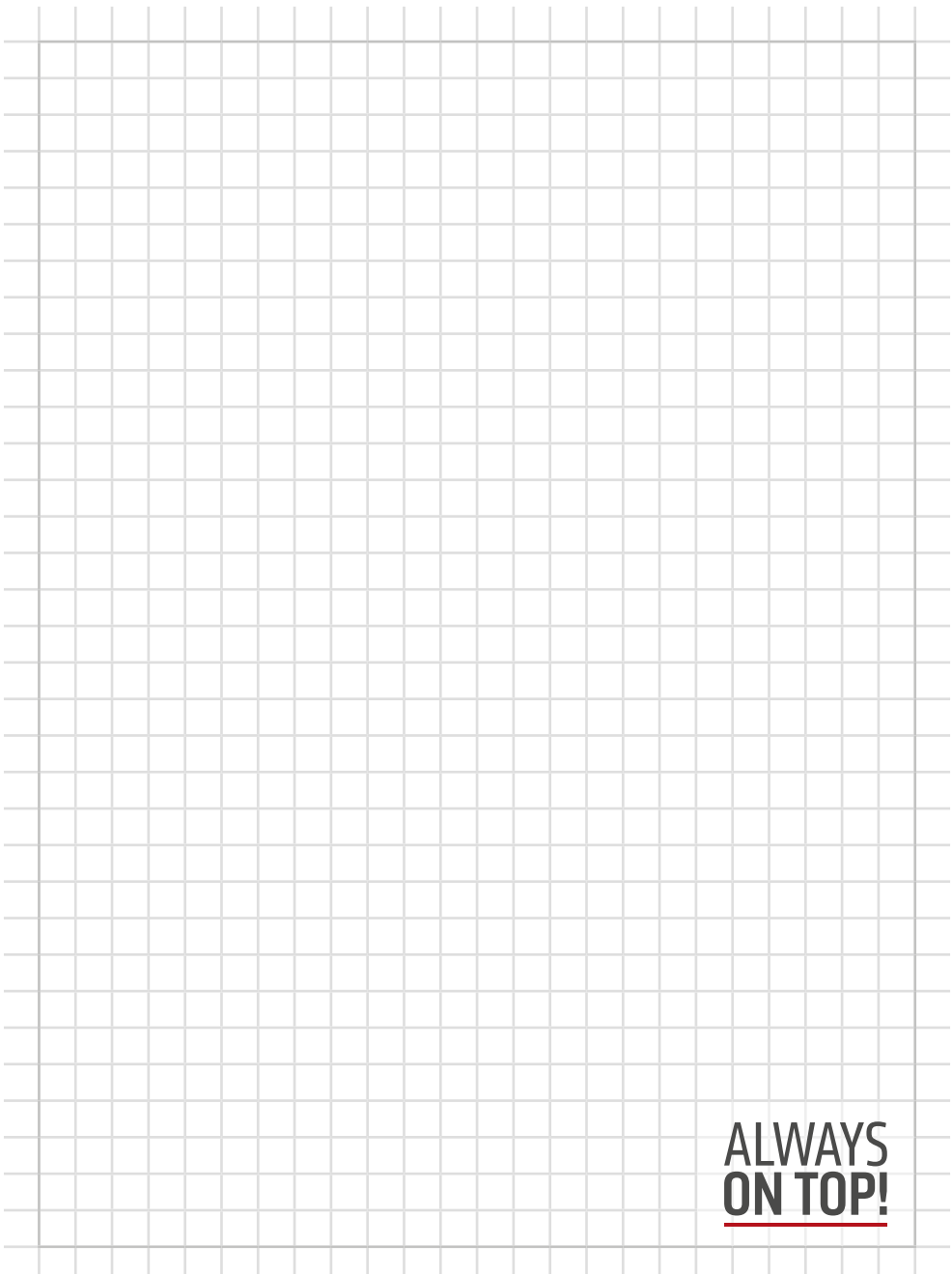

**ALWAYS  
ON TOP!**

# ALWAYS ON TOP!

## **ABS Safety GmbH**

Gewerbering 3  
D-47623 Kevelaer  
Germany

Tel.: +49 (0) 28 32 - 972 81 - 0  
Fax: +49 (0) 28 32 - 972 81 - 29

[info@absturzsicherung.de](mailto:info@absturzsicherung.de)

[www.absturzsicherung.de](http://www.absturzsicherung.de)  
[www.protection-anti-chute.fr](http://www.protection-anti-chute.fr)  
[www.fall-arrest.eu](http://www.fall-arrest.eu)

RS 19, September 2017



[youtube.com/abssafetygmbh](https://youtube.com/abssafetygmbh)



[facebook.com/ABS.Safety](https://facebook.com/ABS.Safety)